

# EXHIBIT A





## SANITARY SEWER SYSTEM

### THE DUNES ON MONTEREY BAY

#### PHASE 1C - 3RD AVENUE AND 10TH STREET IMPROVEMENTS

MARINA COMMUNITY PARTNERS  
CITY OF MARINA CALIFORNIA  
FEBRUARY 2016

#### LEGEND

-  SANITARY SEWER PIPELINES TO BE TRANSFERRED
-  PROJECT BOUNDARY
-  SANITARY SEWER MANHOLE
-  SANITARY SEWER PIPE SIZE (OF 'X" DIAMETER)

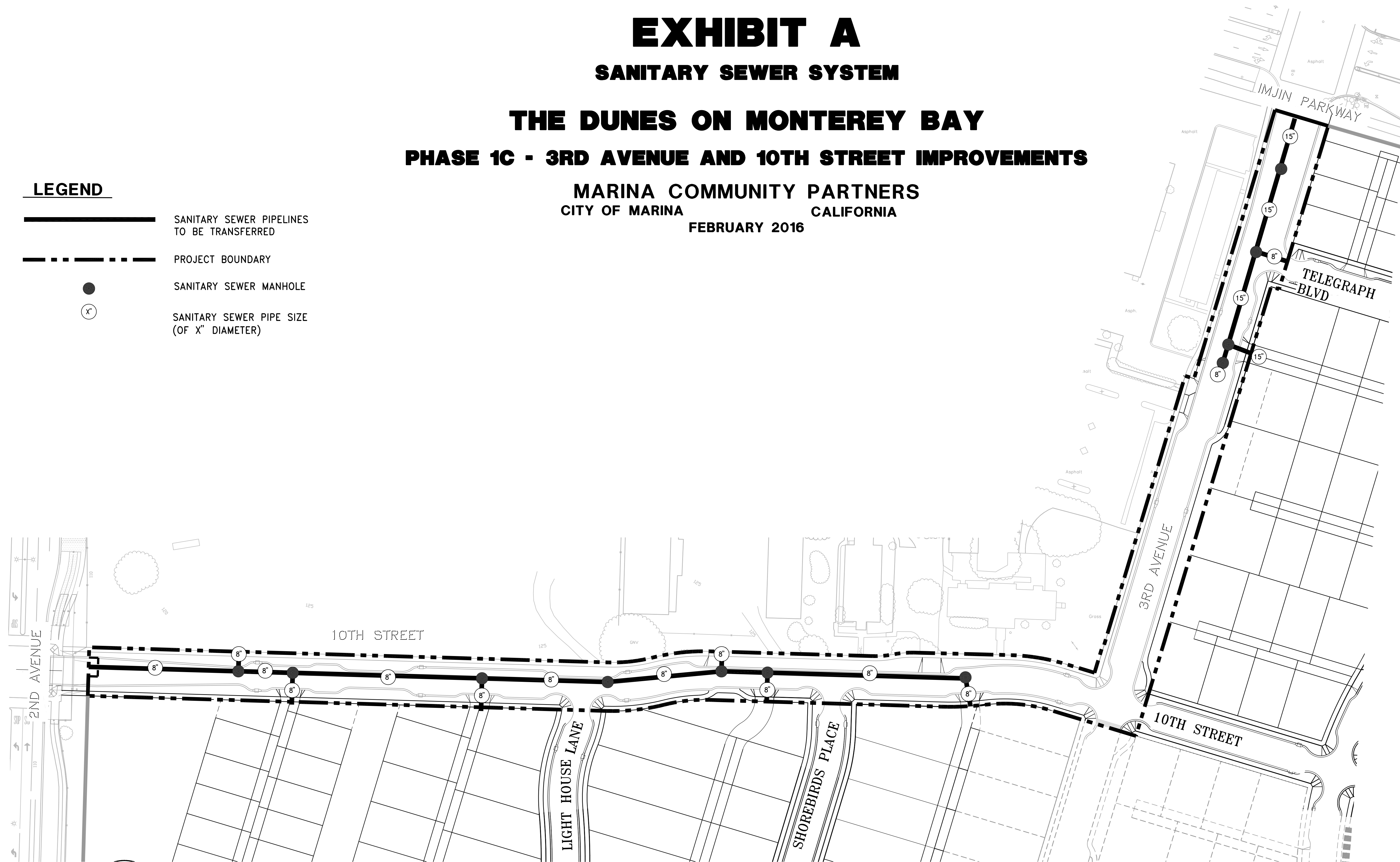
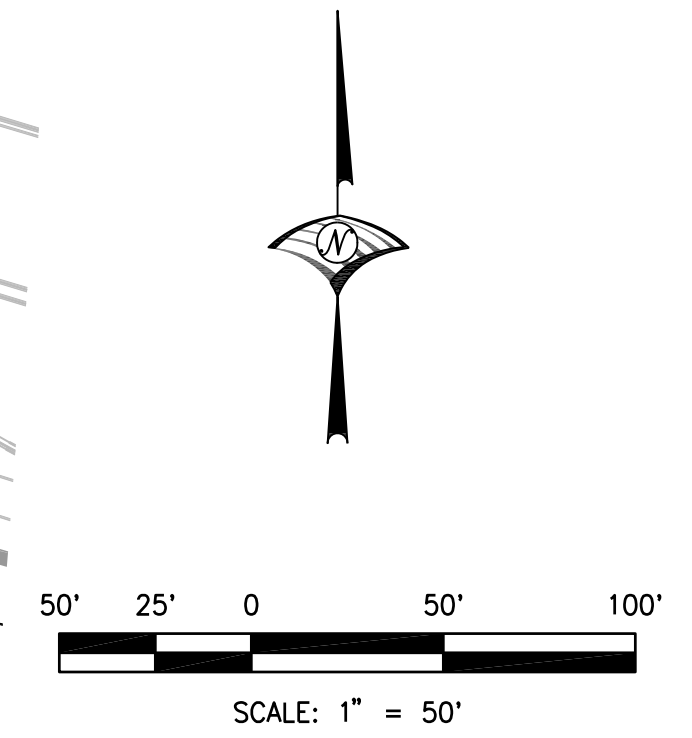

# EXHIBIT B







## DOMESTIC WATER SYSTEM

### THE DUNES ON MONTEREY BAY

#### PHASE 1C - 3RD AVENUE AND 10TH STREET IMPROVEMENTS

MARINA COMMUNITY PARTNERS  
CITY OF MARINA CALIFORNIA  
FEBRUARY 2016

#### LEGEND

-  DOMESTIC WATER PIPELINES
-  PROJECT BOUNDARY
-  DOMESTIC WATER PIPE SIZE (OF X" DIAMETER)
-  FIRE HYDRANT
-  METER VAULT
-  2" IRRIGATION SERVICE WITH 2" WATER METER

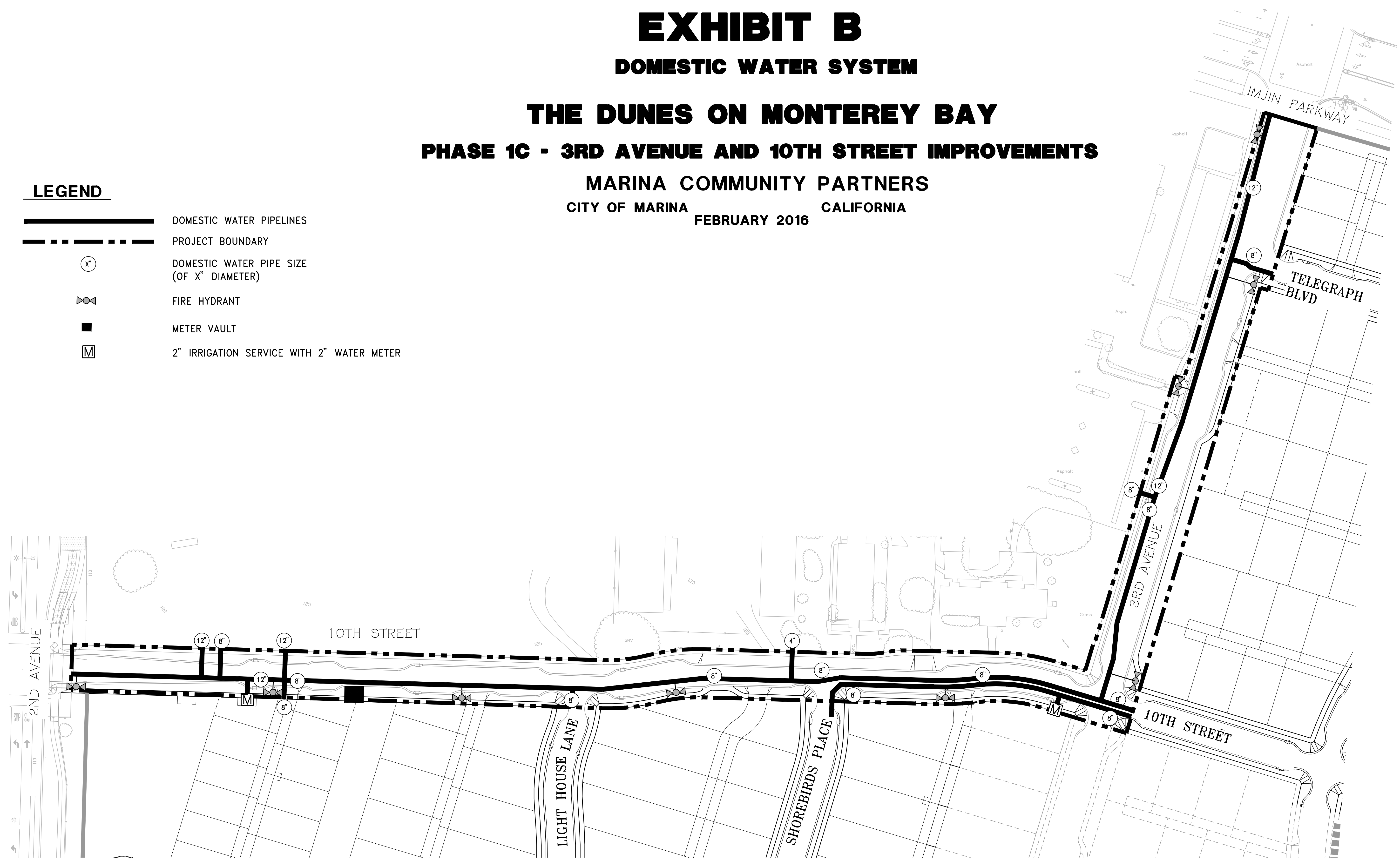
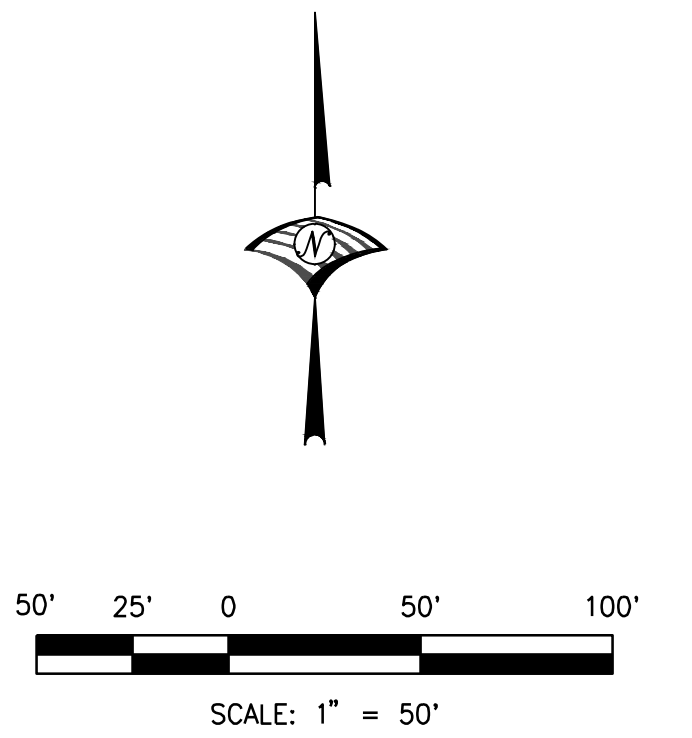

# EXHIBIT C





## RECYCLED WATER SYSTEM

### THE DUNES ON MONTEREY BAY

#### PHASE 1C - 3RD AVENUE AND 10TH STREET IMPROVEMENTS

MARINA COMMUNITY PARTNERS  
CITY OF MARINA CALIFORNIA  
FEBRUARY 2016

#### LEGEND

-  RECYCLED WATER PIPELINES (CONSTRUCTION IN PROCESS)
-  PROJECT BOUNDARY
-  RECYCLED WATER PIPE SIZE  
(OF X" DIAMETER)
-  2" IRRIGATION SERVICE WITH 2" WATER METER

